

# SafetyWhips.com

## Mining & Industrial Safety Equipment

**USA**

TEL: 602.424.2520 • FAX: 602.424.9777 • Email: [sales@safetywhips.com](mailto:sales@safetywhips.com)

**CANADA**

TEL: 604.560.5080 • FAX: 604.560.5090 • Email: [lugo@safetywhips.com](mailto:lugo@safetywhips.com)



# Wheel Chocks • RATINGS FROM 6 TO 240 TONS

## General Purpose, Polyurethane



WC-U01400: Single



WC-U01400-2: Set of 2  
WC-U01400-2R: 2 roped

LOAD RATING	TIRE SIZE	SIZE	WEIGHT
9	35	8.25 L • 7 W • 6 H	2.5
TONS		INCHES	POUNDS



WC-U01500: Single

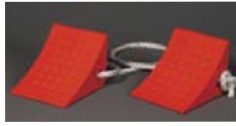

WC-U01500-2: Set of 2  
WC-U01500-2R: 2 roped

LOAD RATING	TIRE SIZE	SIZE	WEIGHT
15	35	11 L • 8 W • 8 H	3.7
TONS		INCHES	POUNDS



WC-U01500-6: Single

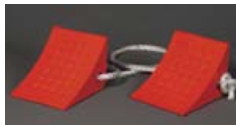

WC-U01500-6-2: Set of 2  
WC-U01500-6-2R: 2 roped

LOAD RATING	TIRE SIZE	SIZE	WEIGHT
15	35	11.3 L • 8.8 W • 8.1 H	6
TONS		INCHES	POUNDS

## General Purpose, Rubber



WC-1100BY-R2: 2 roped

LOAD RATING	TIRE SIZE	SIZE	WEIGHT
N/A	N/A	4 L • 8 W • 4 H	7.5
TONS		INCHES	POUNDS



WC-RB1200: Single



WC-RB1200-2: Set of 2  
WC-RB1200-2R: 2 roped

LOAD RATING	TIRE SIZE	SIZE	WEIGHT
6	32	8.5 L • 7.5 W • 6.25 H	7
TONS		INCHES	POUNDS



WC-RB1010: Single



WC-RB1010-2: Set of 2  
WC-RB1010-2R: 2 roped

LOAD RATING	TIRE SIZE	SIZE	WEIGHT
13	32	7.5 L • 9.5 W • 5.75 H	7.4
TONS		INCHES	POUNDS



WC-RB1020: Single



WC-RB1020: Set of 2  
WC-RB1020-2R: 2 roped

LOAD RATING	TIRE SIZE	SIZE	WEIGHT
13	40-44	10 L • 8 W • 6 H	8.5
TONS		INCHES	POUNDS



For Large Equipment, Polyurethane

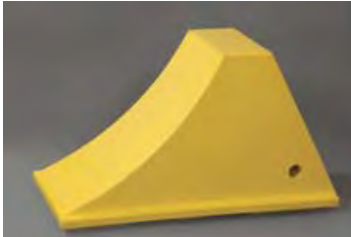

WC-UY2200: Single

LOAD RATING	TIRE SIZE	HARDNESS	SIZE	WEIGHT
70	46-65	50A	21 L • 11W • 12H	22
TONS			INCHES	POUNDS



WC-UY2400 Single

LOAD RATING	TIRE SIZE	HARDNESS	SIZE	WEIGHT
100	95	70A	17.5 L • 14.5 W • 14.5 H	20
TONS			INCHES	POUNDS



WC-UY2700: Single

LOAD RATING	TIRE SIZE	HARDNESS	SIZE	WEIGHT
120	65	70A	10.5 L • 15 W • 12 H	18.2
TONS			INCHES	POUNDS



WC-UY3800: Single

LOAD RATING	TIRE SIZE	HARDNESS	SIZE	WEIGHT
240	142	100A	21.9 L • 14.7 W • 10.6H	39
TONS			INCHES	POUNDS

**CAUTION**  
**WHEELS MUST BE**  
**CHOCKED**  
**BEFORE LOADING**  
**AND UNLOADING**

**Safety Signage –**  
 Wheels must be chocked  
 • Used for chocking regulations compliance  
 • 11" x 15",  
 • Available on steel or adhesive vinyl

# Vehicle ID Panels programmable & dynamic

## Visible up to 750 feet (230 meters)

Positively identify vehicles on the job-site

Bright and Rugged LED Displays.

VID's beam through dusty air and weather.

- Designed for 24 hour use: the Vehicle ID Display is programmed for brighter illumination in the daytime and a sensor dims the LED output for nighttime use.
- VID's can be programmed for all numeric and all 26 alpha characters.
- Once programmed, the numbers or letters use *Locking* technology and do not need reprogramming upon shut down and startup.
- SafetyWhips has built-in *Secure Protection* technology. This insures safe-site operation by preventing VID's from displaying incorrect characters
- Light weight and Easy to mount - VID's can be installed by one technician
- Tough and dependable, SafetyWhips VID's come with a 5 year warranty
- Super-sealed internally as well as externally. SafetyWhips VID's are protected from dirt moisture, high-pressure washing, and vibration. External damage to your VID will not affect its continued operation.
- Available in red, amber, green, blue, white.



Conveniently change the digits (1 to 9) or characters (including all letters A - Z), using magnetic switches. They stay set until changed again with the magnet.



Truck ID in use

**IP Rated**

IP66

IP67

**VID-3N7-12VA**  
tree 7 inch Digits  
9 x 11.5 inches / 12 V

## 12 inch high letters

Product Type  
VID Magnet Sensor  
Numeric Only

	Character Height	Frame Height	Frame Width	Weight	Voltage	Amperage	Wattage
2-Digit		438.15 mm	498.10 mm	7.3 kg	24	.33	7.88
Ext. Spacing	12 inch	17.25 in	19.61 in	16 lbs			
3-Digit		438.15 mm	710.95 mm	9.5 kg	24	.49	11.82
SExt. Spacing	12 inch	17.25 in	27.99 in	21 lbs			
4-Digit		438.15 mm	924.05 mm	12.3 kg	24	.66	15.76
Ext. Spacing	12 inch	17.25 in	36.38 in	27 lbs			



Vertical (at right) available.



## 12 inch to 36 inch high letters

Product Type  
VID Magnet Sensor  
Alpha/Numeric

	Character Height	Frame Height	Frame Width	Weight	Voltage	Amperage	Wattage
2-Character		438.15 mm	622.05mm	7.3 kg	24	1	24
Standard	12 inch	17.25 in	24.49 in	16 lbs			
3-Character		438.15 mm	899.16 mm	9.5 kg	24	1.5	36
Standard	12 inch	17.25 in	35.40 in	21 lbs			
4-Character		438.15 mm	1171.95 mm	12.2 kg	24	2	48
Standard	12 inch	17.25 in	46.14 in	27 lbs			
1-Character		575.31 mm	438.15 mm	7.3 kg	24	1	24
Standard	18 inch	22.65 in	17.25 in	16 lbs			
1-Character		803.91 mm	438.15 mm	9.5 kg	24	1.5	36
Standard	24 inch	31.65 in	17.25 in	21 lbs			



12 INCH

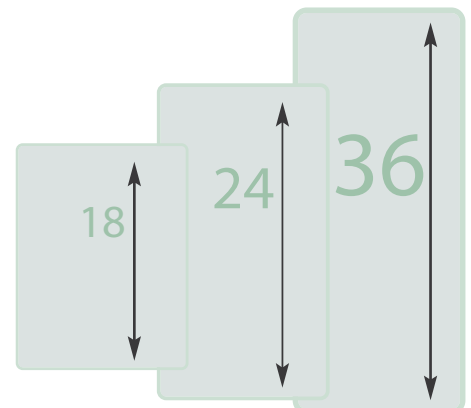

Product Type  
VID Magnet Sensor  
Numeric Only

	Character Height	Frame Height	Frame Width	Weight	Voltage	Amperage	Wattage
1-Digit		1032.15 mm	438.15 mm	12.2 kg	24	2.5	60
Standard	36 inch	40.65 in	17.25 in	27 lbs			

## Arrow Board / Message Board

**New Item!**



### VID-3C12-AMCA-24VA

3 Characters  
17.25 x 38 inches  
12V-24V  
Power rating 57W \*  
28 lbs

Multi-purpose board can be mounted anywhere that directional arrow indicators are required. Additionally, this unit is an integral part of a messaging system on heavy equipment or on stationary structures. The Message Board utilizes the same dependable technology of SafetyWhips' Vehicle ID Displays.

This board can be pre-programmed to display your selected messages regarding Equipment Status, Truck Requires Maintenance, is Down, Not in Service. Also allowing Alternating Use of Arrows for Traffic Guidance along with messages.

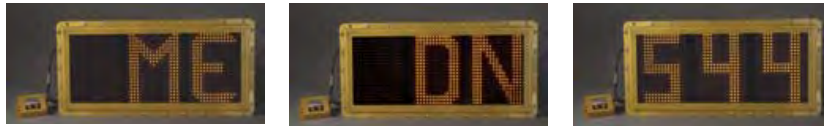

**IP Rated**

**IP66**

**IP67**

## Backlit Vehicle ID Panels, Permanent Text

These Panels are Heavy Duty and Weather Sealed, just like our programmable units. The backlit characters are Reflective and Translucent, for day or night visibility, even when not under power. Available in black or amber

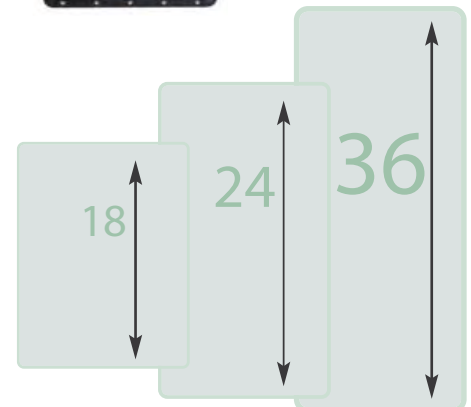
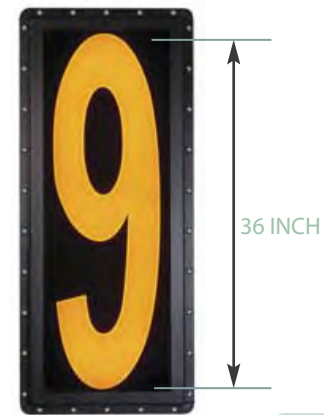

### Product Type

**VID Back-Lit**

**Standard Spacing**

**Alpha/Numeric**

	Character Height	Frame Height	Frame Width	Weight	Voltage	Amperage	Wattage
2-Character		438.15 mm	438.15 mm	6.4 kg	24	1.67	40
Standard	12 inch	17.25 in	17.25 in	14 lbs			
3-Character		438.15 mm	655.32 mm	8.2 kg	24	2.5	60
Standard	12 inch	17.25 in	25.80 in	18 lbs			
4-Character		438.15 mm	838.20 mm	10kg	24	3.33	80
Standard	12 inch	17.25 in	33 in	22 lbs			
1-Character		575.31 mm	438.15 mm	6.6 kg	24	2.08	50
Standard	18 inch	22.65 in	17.25 in	14.5 lbs			
1-Character		803.91 mm	438.15 mm	8.8 kg	24	3.33	80
Standard	24 inch	31.65 in	17.25 in	19.5 lbs			
1-Character		1032.51 mm	438.15 mm	12.7 kg	24	4.17	100
Standard	36 inch	40.65 in	17.25 in	28 lbs			

### Product Type

**VID Back-Lit**

**Extended Spacing**

**Alpha/Numeric**

	Character Height	Frame Height	Frame Width	Weight	Voltage	Amperage	Wattage
2 Character		438.15 mm	498.15 mm	7.3 kg	24	1.67	40
Ext. Spacing	12 inch	17.25 in	19.61 in	16 lbs			
3 Character		438.15 mm	710.95 mm	9 kg	24	2.92	70
Standard	12 inch	17.25 in	27.99 in	20 lbs			
4 Character		438.15 mm	924.05 mm	10.8 kg	24	3.75	90
Ext. Spacing	12 inch	17.25 in	36.38 in	24 lbs			

# Fiberglass Whips

## Heavy Duty Whips

Quick Disconnect Mount and Screw Mount Versions

- 3ft to 12ft heights
- Threaded or Quick Disconnect Base
- Powered or Non-Powered
- Optional Flags
- Optional Whip Color Sheathings,
- A large selection of optional LED Light Heads

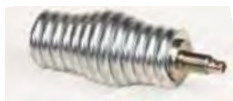

Heavy Duty Spring Mount  
Optional  
see info on Page 12,

**These whips are built for mining and industrial environments. They have proven to be the strongest and most dependable fiberglass whips available.**

**New Item!**



Reflective Whip Sleeve  
FLAG-RS24 : 24 inch length  
FLAG-RS36 : 36 inch length  
FLAG-RS59 : 59 inch length

Part# W05-X w/AL8FUSA Shown at right  
5' Heavy Duty Fiberglass Whip, Threaded Base,  
Flag Reflective X (16 x16") and  
AL8FUSA LED light



### Heavy Duty Fiberglass Whips and Breakdown Versions

#### Product Number Chart

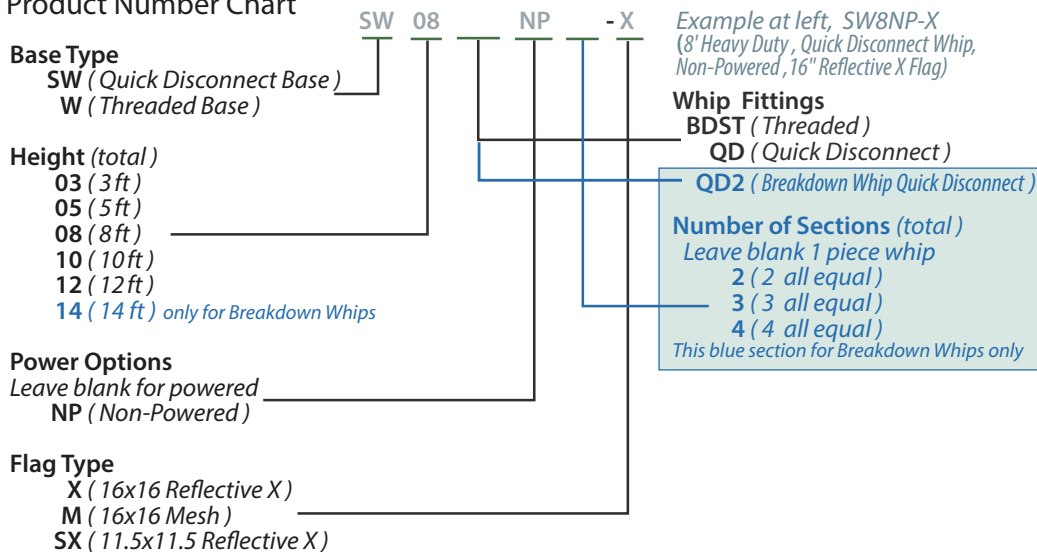

rev041614



Breakdown whip shown above.



# Fiberglass Whips

## Breakdown Whips



Quick-Connect Whip Ends shown above



Screw Thread Mount



Quick Disconnect Mount

### Breakdown Whip:

These segmented whips can separate into two, three or four manageable pieces for storage in the back of the truck, or trunk toolbox. assembles quickly and maintains power to light up your whip light.

## Whip Extensions



**Extender Poles, Fiberglass Whip Extensions**  
Extend your current whip to satisfy site regulations.

- Standard 1, 2, 3, 4 or 6 foot lengths
- Custom sizes available
- Powered or Non-Powered
- Screw Mount or Quick Release

Screw Mount Powered	Screw Mount Non-Powered	Quick Release Powered	Quick Release Non-Powered
Part Numbers	Part Numbers	Part Numbers	Part Numbers
EXT-1	EXT-1NP	EXT-1Q	EXT-1QNP
EXT-2	EXT-2NP	EXT-2Q	EXT-2QNP
EXT-3	EXT-3NP	EXT-3Q	EXT-3QNP
EXT-4	EXT-4NP	EXT-4Q	EXT-4QNP
EXT-6	EXT-6NP	EXT-6Q	EXT-6QNP

## Super Duty Whips

**Added Locked-in Shielding seals components top and bottom.**

See yellow rubber seals in detail photos at right

- 3ft to 12ft heights
- Threaded Base
- Powered
- Optional Flags
- Optional HD Spring

Part# SD05-X-30B-8FA as shown right  
(5ft, 16"x16" X Flag, Super Duty Spring, AL8F Amber LED Light)

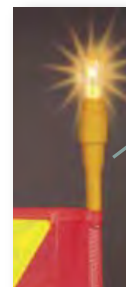

Super Duty Whip Head

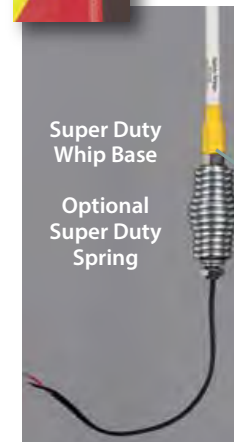

Super Duty Whip Base

Optional Super Duty Spring



### Super Duty Fiberglass Whips

#### Product Number Chart

Super Duty (threaded base only)

Height (total)  
03 (3ft)  
05 (5ft)  
08 (8ft)  
10 (10ft)  
12 (12ft)

Flag Type  
X (16x16 Reflective X)  
M (16x16 Mesh)

SD - 8 X - 309 - 6F A

Example at left, SD-8X-309-6FA  
(Super Duty 8', Reflective X Flag,  
SD Spring Sainless Steel, AL6F Amber LED)

LED Light Color  
R, B, G, W, A, RA

LED Light Head Type  
Leave blank for none  
2C (AL2C)  
6F (AL6F)  
8F (AL8F)

Super Duty Spring Mount  
Powered with 12" Fly Lead  
Leave blank for none  
30B (SD Spring, Zinc Plated)  
309 (SD Spring, Stainless Steel)

**Steel Whips**

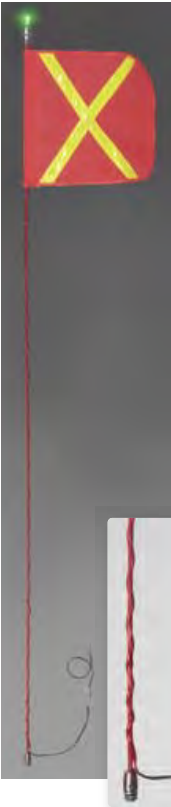

- Ultra Durable; *Work-site and Dune Tested*
- 1156 type Light Socket
- 7ft x 1/4 inch Solid Steel Rod
- Black or Red Rod Sheathing
- Standard Connectors, Threaded Base
- Also available in non-powered version

Shown at left, **AW07D-X W/AL2CG:**  
DT Series 2-pin Connector (Deutsch Connector)  
Red Rod Sheathing, optional Green light head  
in 1156 socket and optional FLAG-16-X  
(Orange flag w/Yellow X)

**Light Duty Safety Flags and Mounts**

**Magnet Mount with  
Light Duty Pole & Flag**  
*non-powered*  
(130 lbs pull magnet used)

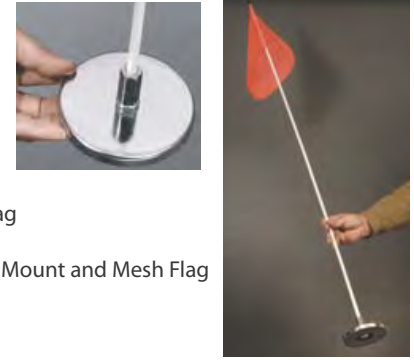

**LW05-M :** 5ft Light Duty Whip  
w / Magnet Mount and Mesh Flag  
**LW07-M :**  
7ft Light Duty Whip w / Magnet Mount and Mesh Flag  
(page 8 for other flags)

**Light Duty Window Mount,  
with Pole & Flag**  
*(non-powered only)*

**New Item !**

**LWW05-M:** 5ft Light Duty Whip  
w / Light Duty Window Mount  
and Mesh Flag

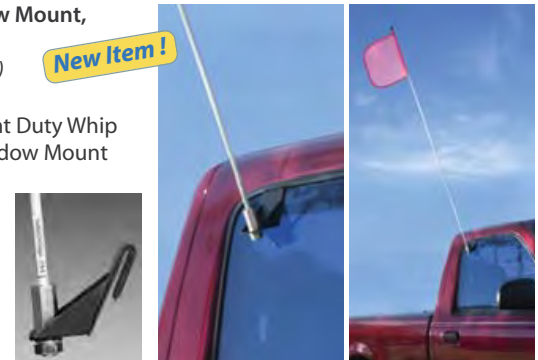

**Quick Releases for 5/16 fiberglass rods.**  
5/16 mount Order # is  
**LW-101 (plus Color)**



Colors codes are:  
R, CL BL, BK

**Telescoping Whips 11 to 21 foot extending lengths**



Part Number	Extended	Collapsed
<b>TW11-X:</b>	11 foot	79 inches
<b>TW13-X:</b>	13 foot	86 inches
<b>TW15-X:</b>	15 foot	93 inches
<b>TW21-X:</b>	21 foot	110 inches

Telescoping Whips: Whip is constructed of rigid wrapped fiberglass that is safe and non-conductive.  
Heavy Duty Fiberglass, Powered with 3 Locking Sections,  
Reflective X (16 x16") Flag. *shown at left*

(at right, shown in down position)  
Telescoping Whips mounted in our  
**HMT: Hitch Mount for Telescoping Whip**  
*Also shown at lower right*



**TW FMT:** Telescopic Whip Flat Mount, w/ whip, locking pin.  
Non-powered mount, provides access to Tele-whip's RCA power input.  
10" x 10" flat plate with TW sleeve welded center, Powder Coated Black.  
Designed for applications when a hitch mount is not available.



4 mounting bolt holes 5/16,  
1/4 inch Steel Plate,  
and weighs 7.8 lbs .

**Side Extended Hitch Mounts and  
Back-up Alarm versions are on page 13**



HMT: Hitch Mount for Telescoping Pole  
*shown with optional hitch pin*





**Airport Checkered Flag**  
**Flag-APF: 36"x36"**  
 Heavy-duty Nylon Airport Flag

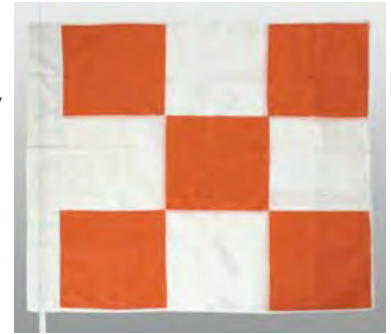

**Windssock and Hardware**

**Flag-WS18-96:** Flag, 18x96 , other lengths available **Flag-WS18-HW:** (Hardware)



**Light Duty Windssock**  
**FLAG-WS-Swivel Kit**  
 (Sock w/ swivel hardware)  
 Whip is optional



**Light Duty Windssock**  
**FLAG-WS8-19:** Flag,



**Pennant Flags**



**FLAG-PO:**  
 Orange Pennant  
*Pennant Flags are 12w x 9h inch flags*

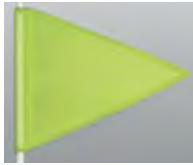

**FLAG-PL:**  
 Lime Pennant

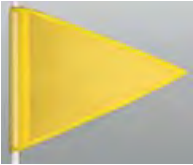

**FLAG-PY:**  
 Yellow Pennant



**Flag-PO-SY:**  
 Orange Pennant  
 Yellow 3M Stripe

Standard Flag Colors:  
 Red, Orange, Yellow, Lime, Green, Blue



*Other Colors Available*

**Heavy Duty Safety Flags 16 x 16 inch**



**FLAG16-O-XY:**  
 16x16 inch  
 Orange mesh  
 reflective X  
 in yellow



**FLAG16-L-XW:**  
 16x16 inch  
 Lime mesh  
 reflective X  
 in white



**FLAG16-O-XW:**  
 16x16 inch  
 Orange mesh  
 reflective X  
 in white

**New Item !**



**Reflective Whip Sleeve**  
**FLAG-RS24 :** 24 inch length  
**FLAG-RS36 :** 36 inch length  
**FLAG-RS59 :** 59 inch length

**Heavy Duty Safety Flags 11 x 11 inch**



**FLAG11-O-XW:**  
 This 11.5 x11.5 inch flag  
 Orange mesh with  
 reflective white X



**FLAG11-O-XY:**  
 This 11.5 x11.5 inch flag  
 Yellow mesh with  
 reflective white X



**FLAG11-O:**  
 11.5 x 11.5 inch flag  
 Orange mesh flag



**Metal "Flags":**  
 These always rigid,  
 location flags can be decal'd  
 as needed.  
*Shown on whip at left*

## Common Features to ALL LED Heads:

- Break Resistant
- 100,000 hours
- Fits 1156 (BA) twist-in sockets
- Weather Resistant
- Polycarbonate Tubing enclosure
- Custom color combinations available

## LED Lights 9-12V

### AL8FC: 8 LED Light Tubes 12V , Animated LED Tubes

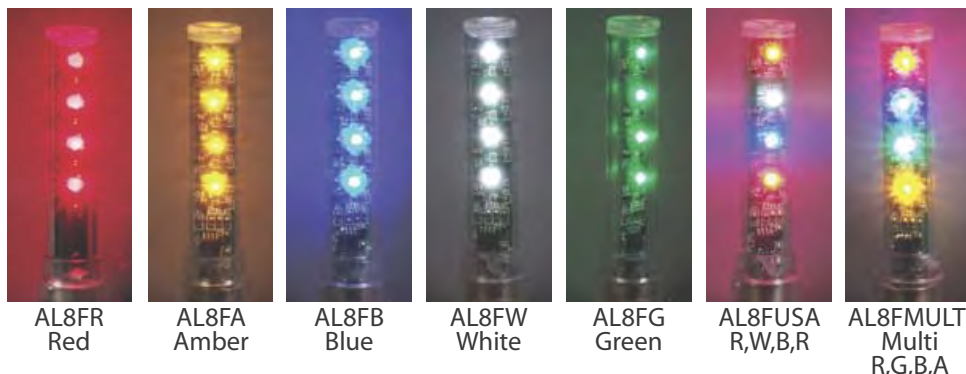

AL8FR Red  
AL8FA Amber  
AL8FB Blue  
AL8FW White  
AL8FG Green  
AL8FUSA R,W,B,R  
AL8FMULTI Multi R,G,B,A

### Mine Specification LED Tubes 12V, Non-Flashing Lights

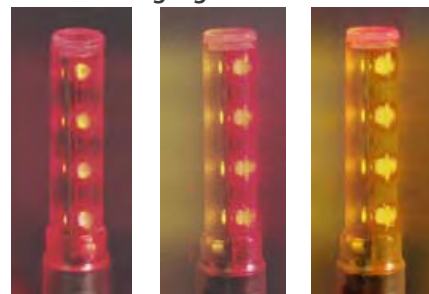

AL8CR Red (non-flashing)  
AL8CAR Amber, Red (non-flashing)  
AL8CA Amber (non-flashing)

### AL6FX: 6 LED Light Tubes 12V , Animated LED Tubes

*BRIGHTEST AVAILABLE WHIP LIGHT*

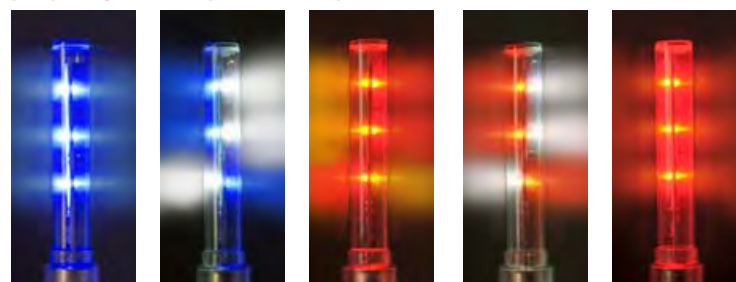

AL6FXB Blue  
AL6FXBW Blue/White  
AL6FXAR Amber/Red  
AL6FXRW Red/White  
AL6FXR Red

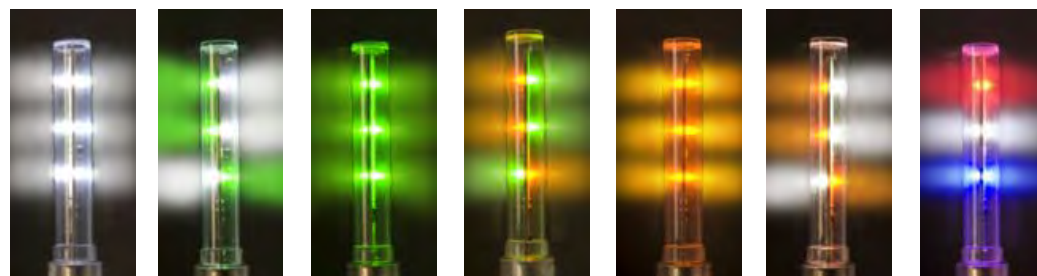

AL6FXW White  
AL6FXGW-Green/White  
AL6FXG Green  
AL6FXAG Amber/Green  
AL6FXA Amber  
AL6FXAW Amber/White  
AL6FXUSA Red/White/Blue

- AL6FXC:**  
6 LED Light Tube  
Added Features
- Strobing LED Light
  - Visible Night or Day and from Miles Away
  - Cross-QuadFlash

24V

### 24 Volt LED Lights

**AL16FC\***, 24Volt, 16 LEDs  
Animated Light Tubes  
\*C=Color, Red or Green  
Other colors by request.



### Low Profile Super Bright 12V

**4x Brighter than Standard 8LED lights!**

*These Super Brights stay warm enough to melt snow and ice..*

This tough light is completely filled with optically clear gel for added robustness.

2-LED, Non-Flashing 100,000 Hours Extra bright and available in 5 colors and Red/Amber (shown below).



**AL4CC\***  
12V  
360 degree, Bi-directional  
Available in amber, (left) red, white, blue & green

\*C+Color, A,R,W,B,G

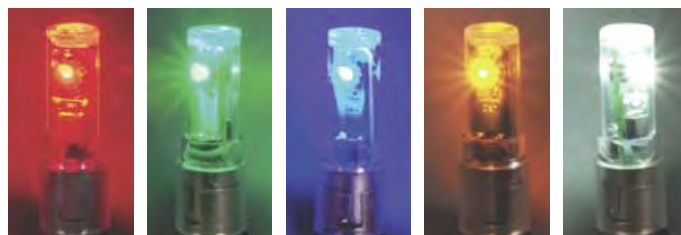

AL2CR Red non-flashing  
AL2CG Green non-flashing  
AL2CB Blue non-flashing  
AL2CA Amber non-flashing  
AL2CW White non-flashing

### Mine Specification Low Profile Super Bright

AL2CAR Amber, Red non-flashing



Self-Powered Options



**9 VOLT BATPACK:** Use for a great temporary alternative to hard-wiring your whip. An excellent back-up power supply for your AL8F or AL6F whip-top lights  
 Expected hour of use:  
 With AL8F-CLED, 25 to 30 hours  
 With AL6F LED, 12 to 15 hours



**BATPACK-ER KIT:** The BatPack-ER Kit, fits an existing 1156 socket whip or use set-screw base. It can also be used as a temporary light source in lieu of wiring. Includes both base options, the 3 CR2 3 V batteries, and AL8F light (in your choice of color).



**SL-182R:** Red Lens  
**SL-182A:** Amber Lens  
 Portable Signal Lights, Magnetic Mount.  
 A weather resistant alternative to road flares or use in towing.

**New Item!**

Warning Lights



SW-255TS-"color"



Available in:  
 Red, Amber, Clear, Blue and Green lenses

The SW255TC and SW255TS Series offer field selectable flash patterns of double flash or quad flash via an internal jumper. The polycarbonate lens easily twists on/off the durable and lightweight polycarbonate plastic, universal mount, flanged base. The circuit is completely encapsulated for increased shock and weather resistance and is also protected with a low voltage shutdown feature. Ships complete with mounting hardware and instructions.



SW-255TSM-"color"

**SW255TC Series:**  
**SW255TC:** Flange Mount  
**SW255TCM:** Magnetic Mount  
**SW255TCV:** Vacuum Magnetic Mount  
 High Dome: 6-11/16"H x 6-13/32"Dia., 3 lbs.

**SW255TS Series:**  
**SW255TS:** Flange Mount  
**SW255TSM:** Magnetic Mount  
**SW255TSV:** Vacuum Magnetic Mount  
 Low Dome: 4-3/4"H x 6-13/32"Dia., 3 lbs.



SW-255TSV-"color"

**SW255TC & SW255TS Specifications:**  
 Mounting: Universal Flange Mount  
 1" Pipe mount Magnetic Mount  
 Vacuum Magnetic Mount  
 Approvals: SAE J1318 Class 2:  
 Amber, Blue, Clear, Red (Quad Flash only)

Voltage: 12V-48V DC  
 Amp Draw: 1.2 Amps @ 12V DC  
 0.6 Amps @ 24V DC  
 0.3 Amps @ 36V DC  
 0.175 Amps @ 48V DC:  
 Double Flash: 7 joules  
 Quad Flash: 10 joules  
 Lens color: Amber, Blue, Clear, Green, Red

Ask us about Emergency Light Bars



SW9200S-X,  
 SW9200SM-X  
 SW9200SV-X



## Threaded Whip Receiving Mounts

Steel  
Thread mounts  
Optional  
Left: 519.343NP  
Center: 519.343.RCA  
Right: 519.343



## Thread to Quick Disconnect Adapters:

For use converting 1/2 inch 20 thread whip connection to QD  
Available as Adapter Only or in Kit with Receiving QD Mount

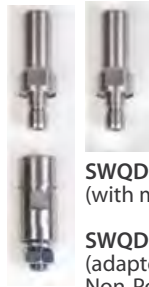

SWQD-KIT-NP,  
(with mount)  
SWQD-WA-NP  
(adapter only)  
Non-Powered



SWQD-KIT-PT  
(with mount  
w/Wire Lead,)  
SWQD-WA  
(adapter only)  
Powered



SWQD-KIT-R  
(with mount)  
w/ RCA Wire Lead,  
SWQD-WA  
(adapter only)  
Powered



**Heavy Duty Spring Mount**  
Highly recommended to help reduce whip breakage.

Shown below, left to right are,  
519.309 Stainless Steel  
519.30B Zinc Plated Steel  
519.30C Chrome Plated Steel



**Stainless Steel QD Base**  
Use with quick disconnect whips  
Shown below, left to right are,

SWQD-NP: Non Powered  
SWQD-PT: wire in pigtail  
SWQD-R: RCA Type power connector  
w/ RCA type pigtail,

**New Item !**



**SPM: Stake Pocket Mount**  
Attach whip to this mount after slipping it into a truck's post hole and expanding the base.  
Heavy Duty Aluminum, no drilling needed, a solid fit with adjustable and removeable base plates.  
Shown above and on truck at above right.

**New Item !**



**FSM: Universal Flat Surface Mount**



FDSM in  
Up position

Down position

## FDSM: Fold Down Mount

Attaches whips to the truck side wall, tool box or back rack. It provides a quick and efficient way to fold whips down when leaving a job site or passing under low overhangs.



**ABM: Angle Bracket Mount**  
Attach whips to toolbox, rack or truck bed with this heavy duty bracket.

**New Item!**



**FDVM Side Wall Mount**  
**NEW** – Side Wall Mount  
 Great for panel trucks and vans.  
 Allows whip fold down to right or left  
 Use with RH01 Whip Retaining Hook  
 (on page 14)



**New Item!**

## Fire Hydrant Mount

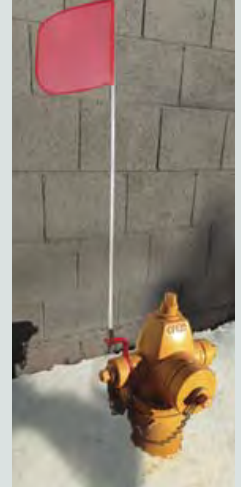

**FHM: Fire Hydrant Mount**  
 Find Hydrant in deep snow and  
 avoid overplowing and dive overs



**519.320-V: Window Mount**  
 Shown with optional  
 cigarette cord power adaptor.



**Magnet Mount 519.330**  
 Shown with optional  
 cigarette cord power adaptor.



**519.821:**  
 cigarette cord power adaptor  
 ships with Powered Magnet Mounts.  
 Available as a separate part.



**519.33LHR (red) Magnet mount, powered**  
 A Quick-Release Mount is a typical option when  
 ordering a Powered Magnet Mount.

in use at lower left : 519.33LHRNP (red) with powered  
 Q/R whip and Quick-Release Mount, FLAG16-O-XW



**519.33LRNP (red)**  
 Magnet mount, non powered



**519.33LYNP (yellow)**  
 Magnet mount, non powered



**519.33LHRNP (red)**  
 Magnet mount, non powered



**519.33LHYNP (yellow)**  
 Magnet mount, non powered



**519.33LR (red)**  
 Magnet mount, powered



**519.33LY (yellow)**  
 Magnet mount, powered



**519.33LHR (red)**  
 Magnet mount, powered



**519.33LHY (yellow)**  
 Magnet mount, powered



Hitch Mounts are available with either a screw mount for the standard threaded whip, a quick release mount for quick connect whips or a telescoping adapter for telescoping whips and Breakdown Whips. **Specify 2 inch or 1.25 inch receiver.** Order with or without a 107 dB backup alarm.



hitch pin,  
optional part



HM1: Hitch Mount with Standard Screw Mount



HMQD :Hitch Mount with Quick-Connect Mount



HMT: Hitch Mount for Telescoping Pole shown with optional hitch pin



HM1S: Hitch Mount with Standard Screw Spring Mount  
\*107 db Backup Alarm available



HM1A :Hitch Mount with Standard Screw Mount and 107 dB Backup Alarm



HMQDA :Hitch Mount with Quick-Connect Mount and 107 dB Backup Alarm



HMTA :Hitch Mount for Telescoping Pole with 107 dB Backup Alarm

## Extended Hitch Mounts, powered

Non-Powered Hitch mounts are available

Extended Hitch Mounts allow you to use your vehicle's hitch receiver for warning whips while still being able to utilize your tailgate or rear hatch when necessary. Extended hitch mounts are available for solid fiberglass warning whips and for Telescoping Whips. **Mount only available for 2" or larger hitch receivers.**

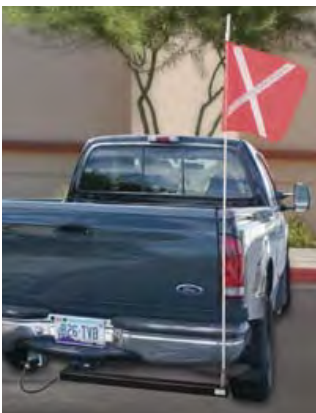

HM1L: hitch mount for threaded whip with 7-Way power plug



HM1LA: hitch mount for threaded whip with 7-Way power plug and Back-Up Alarm



HMLQD: hitch mount for Quick Disconnect whip with 7-Way power plug



HMLQDA: hitch mount for Quick Disconnect whip with 7-Way power plug and Back-Up Alarm



HMLT: hitch mount for Telescoping Whip with 7-Way power plug



HMLTA: hitch mount for Telescoping Whip with 7-Way power plug and Back-Up Alarm



# Accessories



RCA1 : Dual-wire, Right angle Plug  
RCA2 : Dual-wire, Straight Plug  
HP2 : Single-wire, Hot Plug



Deutsch DT Series 2 pin connector.  
This Dual-wire connector offers extra protection in harsh environments



519DC:  
24 to 12 Volt DC Converter



519.821: cigarette cord 10 ft.,  
power adaptor



RH01 Hold-down Hook  
Hold-down hook  
for Fiberglass Whips



HM-TAILER PLUG:  
Pollak 7-Way Trailer End Plug



HM-B/U-Alarm  
Backup Alarm, 107db  
This compact, high sound level alarm is specifically designed for 107 decibels.  
This solid state alarm is polarity protected. The 270 alarm has an approximate current draw of 0.5 Amps.  
Self-resonating circuitry automatically adjusts to environmental conditions to ensure a constant 107 decibel output. Weight: 12 oz. (340 g)

# VID Accessories

PC-EXT-50-1:  
50 foot power cord,  
two wire and Deutsch connector



PC-EXT-50-2:  
50 foot power cord,  
Deutsch connector both ends



Deutsch DT  
Series 2 pin connector.

# VID Brackets, Pre-Drilled

- Mount to any SafetyWhips VID sign
- Hardware available upon request
- Made of powder coated steel
- (Raw steel available for welding applications )

Images shown at the right...  
(A) VID-S10  
(B) VID-S10 (alternate view)



# Personal Safety

## Hard Hats



**Hard Hat - Full (A, in photo)** Lightweight Reduces impact of falling objects, but does not provide unlimited protection. 4-Point nylon suspension Adjustable head strap w/ ratchet head strap.

**Hard Hat - Front (B, in photo)** Lightweight with Superior fit and comfort. Swivelling pivot head strap. Adjustable pinlock or ratchet-style head strap. 4 or 6-point nylon suspension.

Add Your Logo to Hard Hats



Contact us for Logo, Safety Decals or Certification Stickers from Industrial Decals Co.

## Safety Vest



**SSV-GN-"size"**: shown above Multi-pocket Surveyors Vest, zipper Green, Med, Large, XL, XXL, XXXL

**SSVM-GR-"size"** no photo available Mesh panels in upper front and mid-back Multi-pocket Surveyors Vest, zipper Green, Med, Large, XL, XXL, XXXL



**SV014:** Vest, Fluorescent Soft Mesh with Reflective Yellow

shown with **AB011:** Arm Band Fluorescent Reflective



**SSV-OR-"size"** shown above Multi-pocket Surveyors Vest, zipper Orange, Med, Large, XL, XXL, XXXL

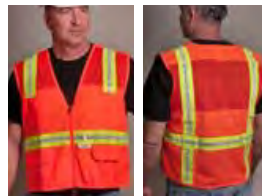

**SSVM-OR-"size"** shown above Mesh panels in upper front and mid-back Multi-pocket Surveyors Vest, zipper Orange, Med, Large, XL, XXL, XXXL



**SV012:** Fluorescent yellow mesh with zipper

## First Aid and Body Fluid Clean-up Kits



**First Aid Kit for 10 persons**  
Plastic Adhesive Strips, Bandages, Gauze Pads, Gauze Bandage, Adhesive Tape, Antiseptic Towelettes, Aid/Burn Cream Packets, Bandage Scissors, Forceps, Gloves, First Aid Guide



**Body Fluids Clean-up Kit**



**First Aid Kit for 25 persons**  
This industrial First Aid Kit is designed for a 25-person workplace meeting OSHA requirements but also ideal for any office or home. The compact metal case is easily transportable with convenient handle and easily stowable or wall-mountable. Cold-pack, Plastic Adhesive Strips, Bandages, Gauze Pads, Gauze Bandage, Adhesive Tape, Antiseptic Towelettes, Aid/Burn Cream Packets, Gloves, First Aid Guide, medical scissors and tweezers,

## 3M Scotchlite™ Diamond Grade™

This reflective prismatic sheeting offers optimum visibility for the backs and sides of trucks. This Prismatic effect produces a high visibility from multiple angles.

## 3M Conspicuity Tape, DOT marking for vehicles and signage.

- 7 year warranty not to fade, crack, peel or discolor.
- Meets NHTSA Regulations 49 CFR 571.108 and FHWA 49 CFR 393.13
- Reflects up to 900 candlepower brightness
- Precut alternating color sections for easy application
- Superior visibility from all angles

**TAPE-2-RW:** Adhesive, Red and White, also available in other colors

**TAPE-2M-G:** Magnetic, Green and White, also available in other colors

### Available as:

- Magnetic or adhesive
- 50' or 150' rolls
- Single or Multi-Color
- 1 to 4 inch width



**SAFETY FLAGS ON DOWEL:** Mesh Safety Flag Heavy Duty  
These Mesh Flags are made of fluorescent knitted vinyl (KV) mesh material.  
Recommended to be used on fast moving vehicles.  
These flags will overcome the objections from "whipping," such as cracking, peeling, or fraying.

### To Order Specify :

- Flag Type: Heavy Duty Mesh or Vinyl
- Flag Size: 18"x18" or 24"x24"
- Dowel Length: 18", 24", 36" or 48"



## Road Hazard Kit



Features: 3-Safety triangles with bases  
Fluorescent strips provide maximum warning day or night  
Reflectors sealed from dust & moisture,  
Plastic-hinged storage case.  
4- Road Flares, Road Flares  
20 min RED, no stand, no spike

## Fire Extinguishers



### Fire Extinguishers Available in 5 lbs, 10 lbs, 20 lbs and 30 lbs, vehicle brackets available

Buckeye's Monoammonium Phosphate fire extinguishers are designed for use in combating Class "A", "B", and "C" type fires. ABC extinguisher provides the widest and most practical range of extinguisher protection coverage. ANSI/UL 299 and ANSI/UL 711 standards. US Coast Guard approved for Type B:C



### Fire Extinguishers Brackets

**FE-VB-10t-HD** for 10 lb Tall dry chemical, 5.0 in. – 5.25 in.f

**FE-VB-20/30-HD** for 20 lb and 30 lb dry chemical, 20 lb CO<sub>2</sub>, Class D, 7.0 in. – 8.0 in.



*We are with you, wherever you are working.*



Page 1	Wheel Chocks	Page 10:	Self Powered Lights Warning Lights
Page 2:	Wheel Chocks	Page 11:	Whip Mounts
Page 3:	Vehicle ID Panels Programmable	Page 12:	Whip Mounts
Page 4:	Vehicle ID Panels Arrow / Message Panels Backlit Vehicle ID Panels,	Page 13:	Hitch Mounts
Page 5:	Fiberglass Whips, Heavy Duty	Page 14:	Whip Mount Accessories VID Accessories
Page 6:	Fiberglass Whips Super Duty Break-Down Whips Whip Extentions	Page 15:	Safety Vest Hard Hats First Aid and Body Fluid Clean-up Kits
Page 7:	Steel Whips Lite Duty Whips and Mounts Telescoping Whips and Mounts	Pages 16	Reflective Tape Road Hazard Kit Fire Extinguishers
Page 8:	Windsocks Safety Whip Flags	Pages 17	Photos from Job Sites
Page 9	LED Light Heads for Whips	Pages 18	Index
		Back Cover :	Industrial Decals Co

Web Cat. REV 11/23/14







SafetyWhips USA 2115 W. Mountain View Rd., Phoenix, AZ 85021  
 Tel. 602-424-2500 Fax: 602-424-9777  
 Sales@SafetyWhips.com  
 www.SafetyWhips.com

SW SafetyWhips Canada, 677 – 192 St. #107 Surrey, BC V3S 3X1  
 tel 604.560.5080 fax 604.560.5090  
 Lugo@safetywhips.com  
 www.SafetyWhips.ca



Vehicle Wraps, Graphics & Lettering  
 OSHA / MSHA / ANSI Compliant :  
 Decals, Signs, and Tags  
 Contact Industrial Decals Co. at – tel 602.235.0085  
 Email: Sales@Industrialdecalsco.com

[www.Industrialdecalsco.com](http://www.Industrialdecalsco.com)



Equipment ID Decals

Item Branding



Vehicle Wraps



DOT Placards and Signs



Custom NFPA Diamond Signs

OSHA Safety Signs and Decals



Chemical Hazmat

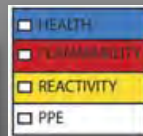

Bar Coding

Fire Extinguisher Tags



Customize Any Decal

- Branding for Vendors & Distributors
- Product & Marketing Labeling
- Control Panels
- Hard Hat Decals
- Magnetic Signs
- Vehicle Wraps, Graphics & Lettering
- Window Graphics
- Banners
- Wall Murals
- Pull-up Graphics